

# Summer Flower Pots

© Cindy Rodenmayer 2012



6 1/2 x 9 1/2 inch unfinished block



Here is a collection of easy to mix and match flower pots and flowers. Use them to create anything! An entire quilt, a wall hanging, placemats or a mug rug. Use up those scraps you have been saving!

This is designed with fusible applique in mind, but can easily be used for hand applique, just add a 1/4 inch seam allowance to each patch. Templates are full sized.

This is my original design.

The copyright for this pattern allows you to make one copy of this pattern for your personal use only. You may not copy this pattern to give it to others or teach it to others without the express permission from the designer. You may not copy or distribute the pattern by any means, electronic or otherwise. All rights are reserved.

Sindy Rodenmayer  
1341 Kynn Drive  
Garland Texas, 75041  
[s\\_rodenmayer@yahoo.com](mailto:s_rodenmayer@yahoo.com)  
[www.fatcatpatterns.com](http://www.fatcatpatterns.com)

# Summer Flowers - Sindy Rodenmayer

Key Block (26/50 actual size)

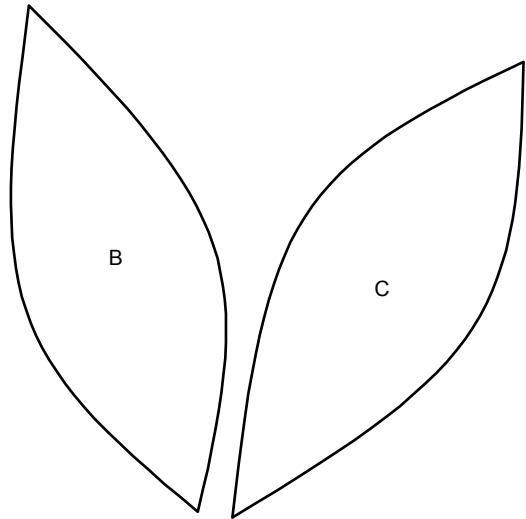
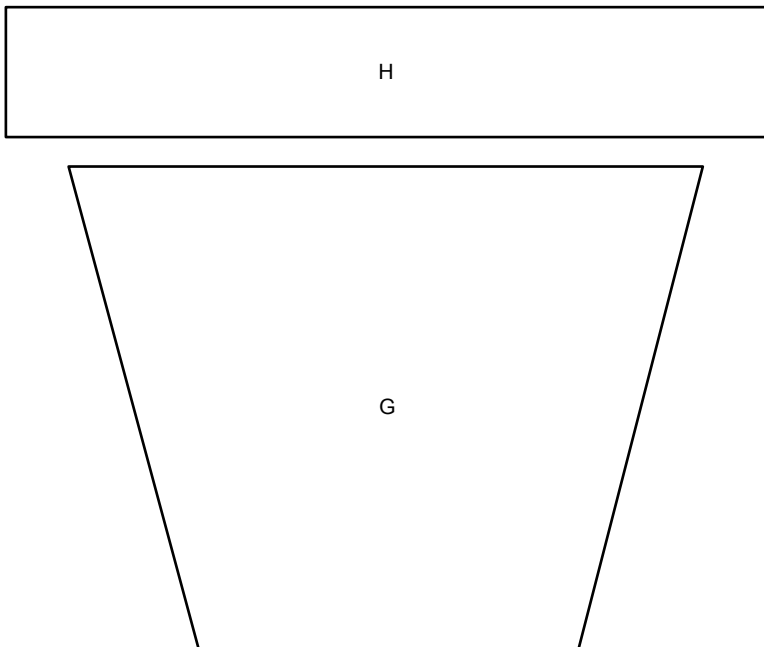
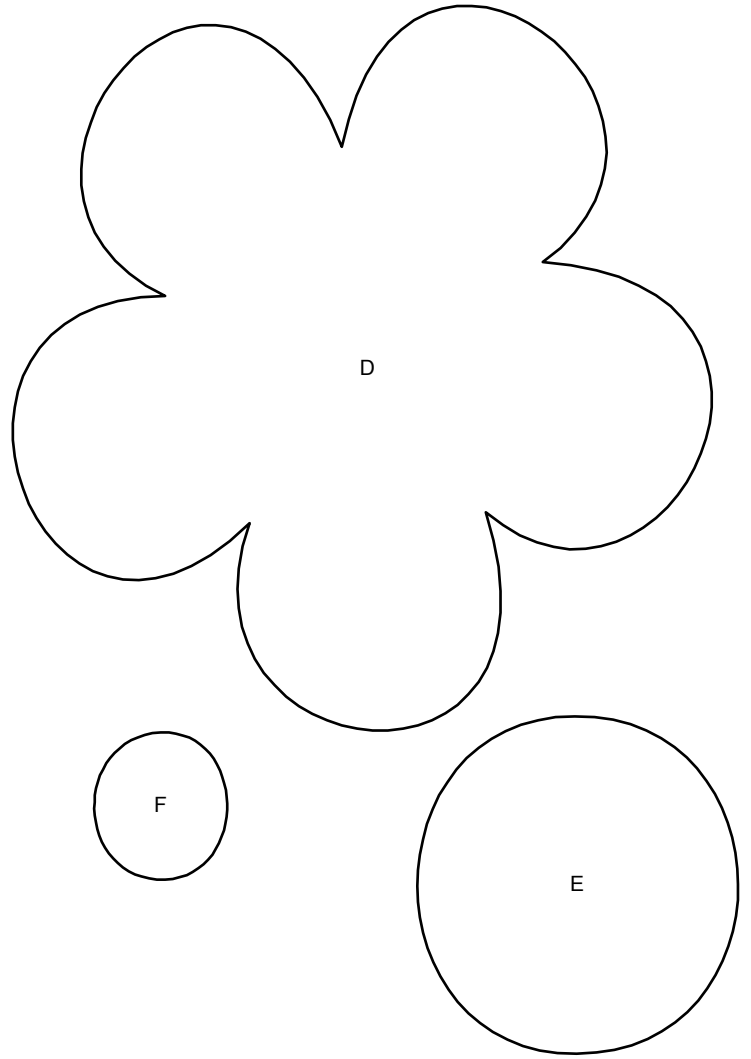
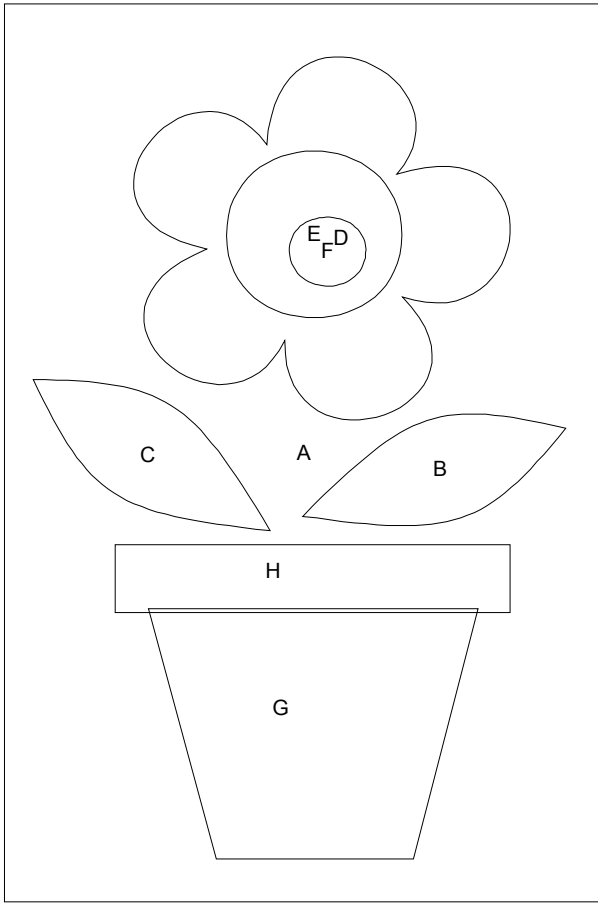

# Summer Flowers - Cindy Rodenmayer

Key Block (26/50 actual size)

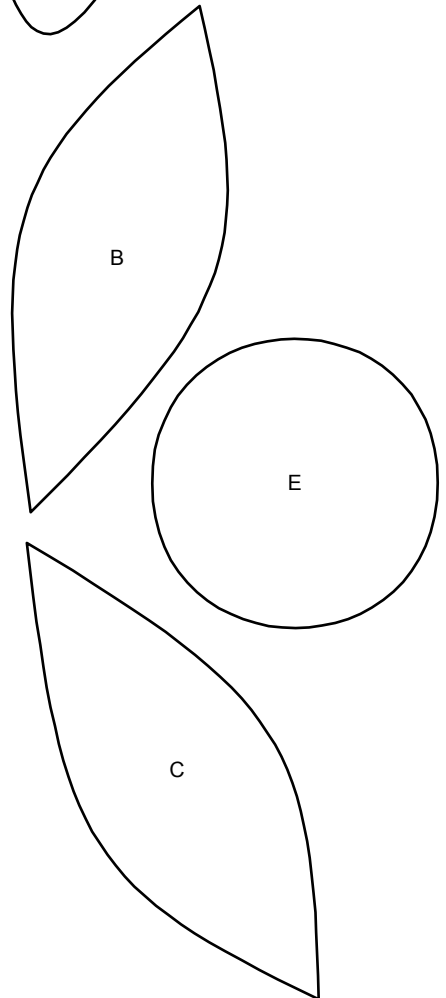
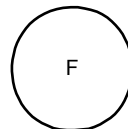
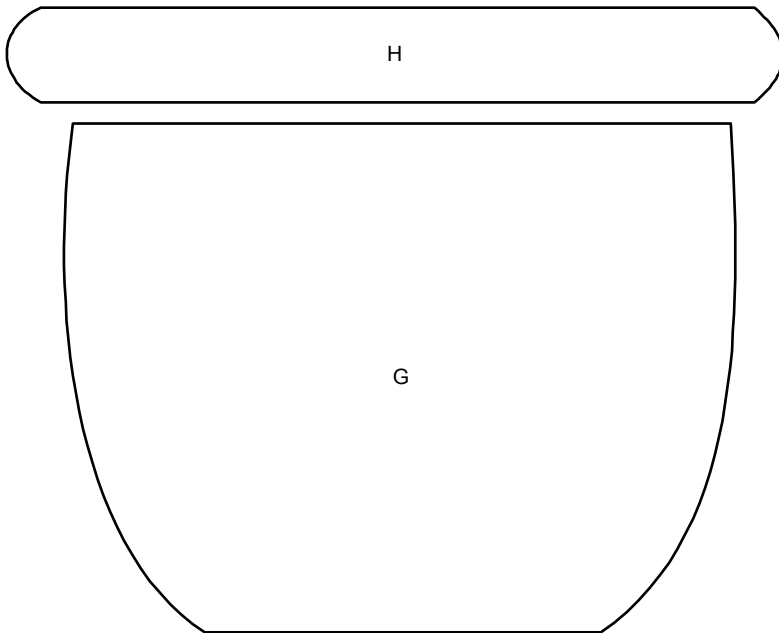
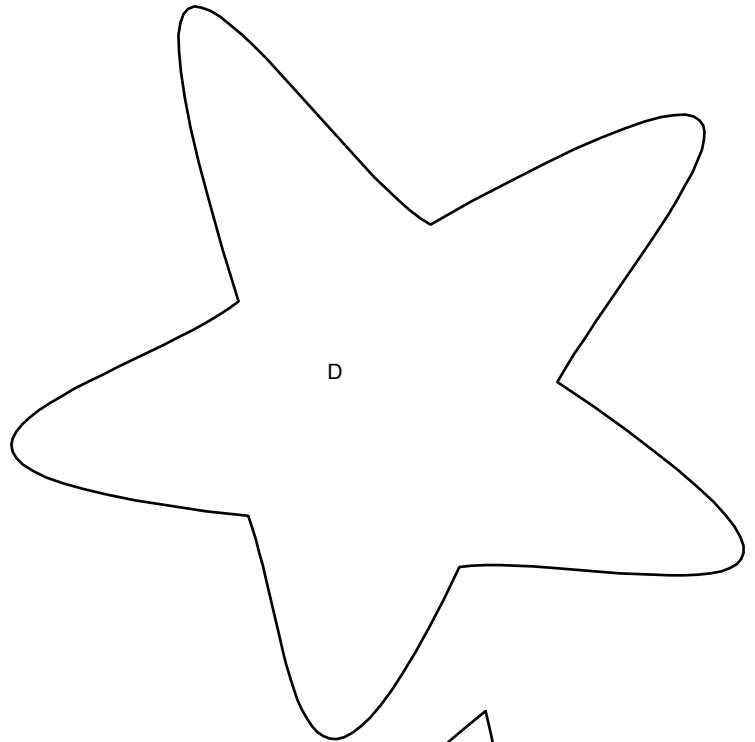
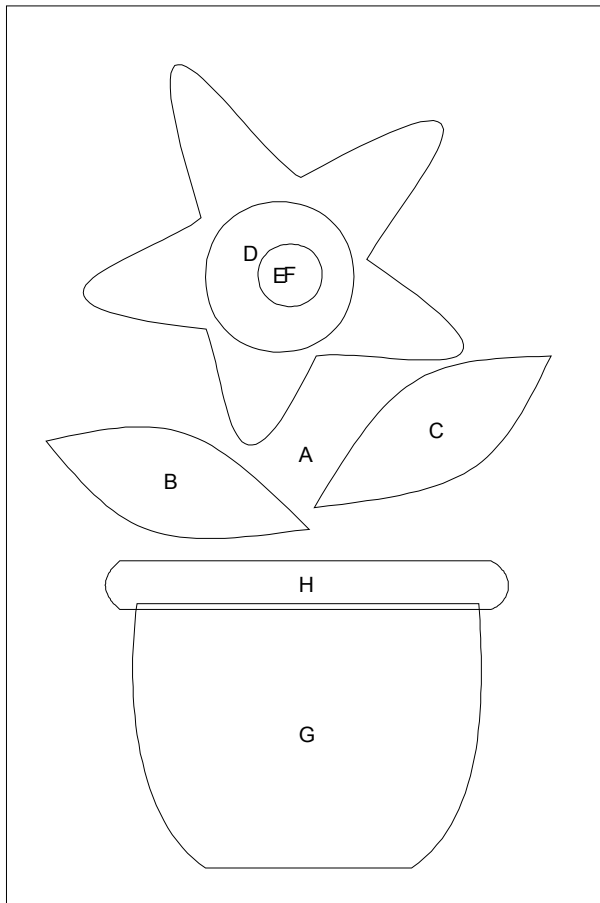

# Summer Flowers - Cindy Rodenmayer

Key Block (26/50 actual size)

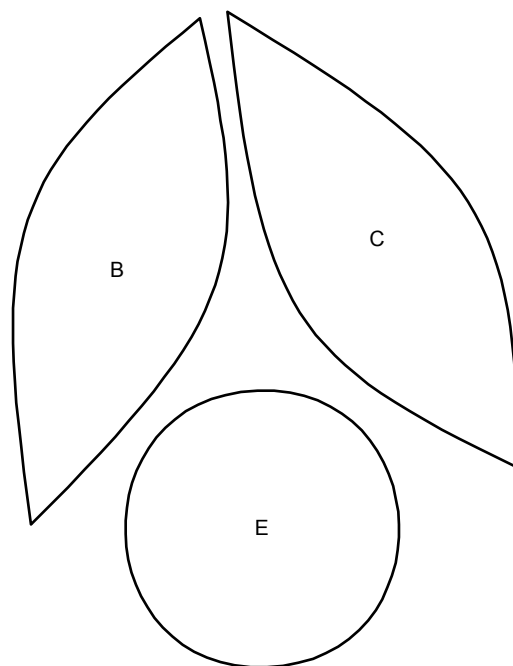
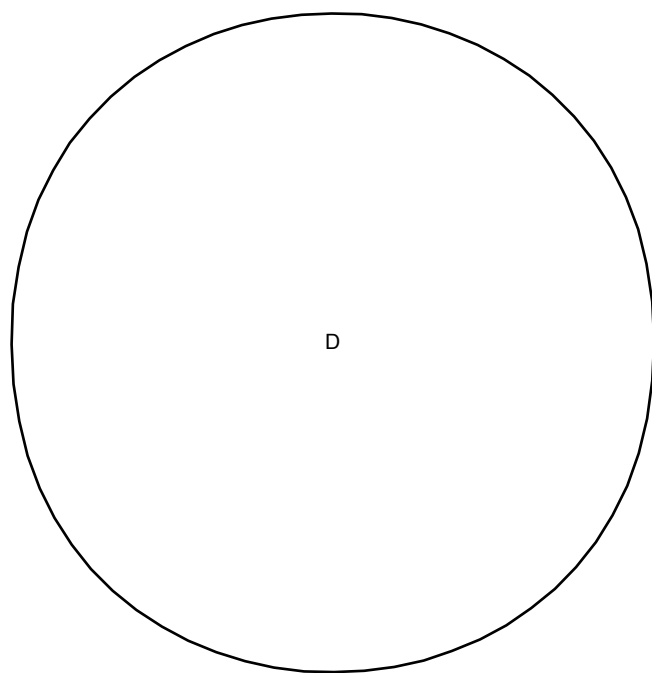
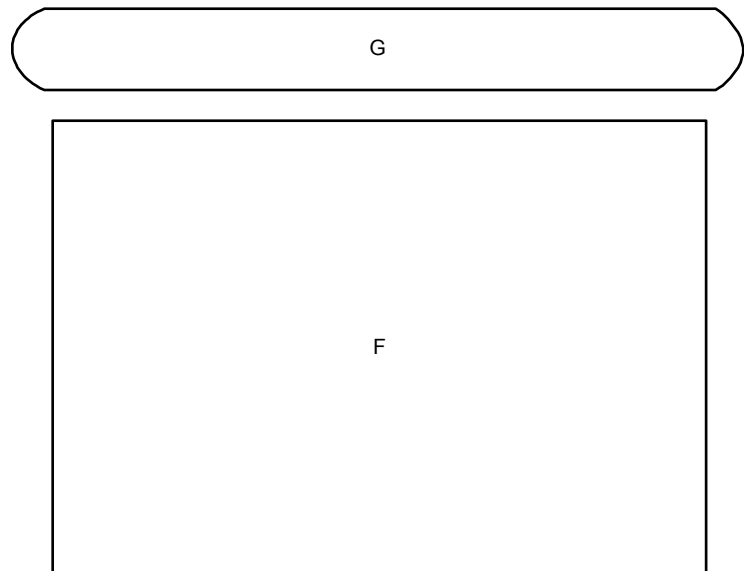
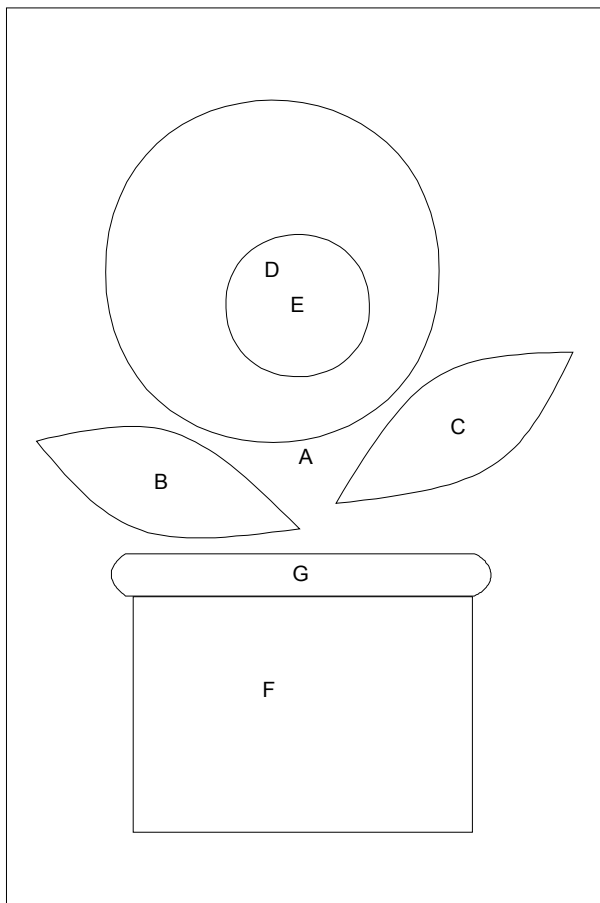

# Summer Flowers - Cindy Rodenmayer

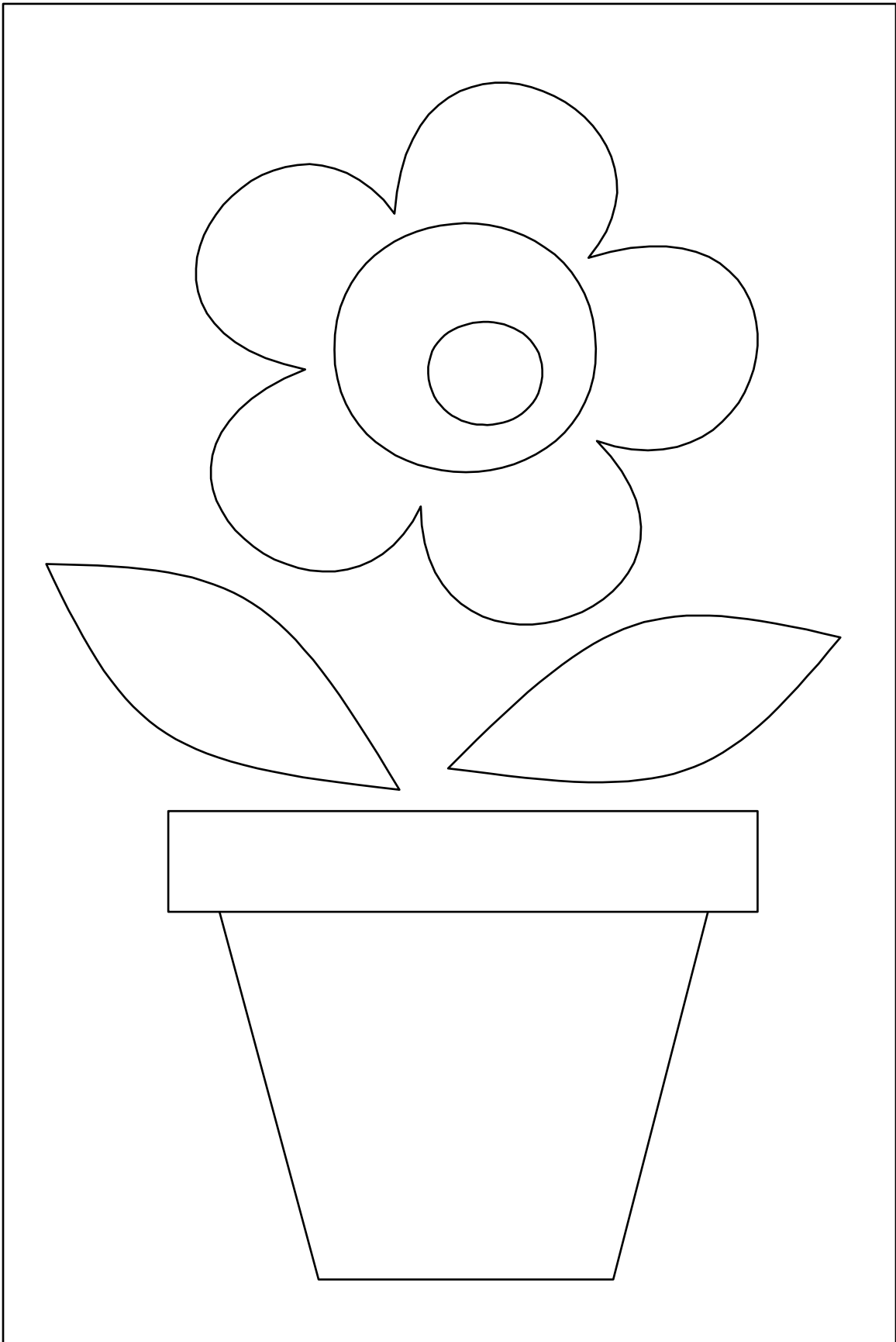

[www.fatcatpatterns.com](http://www.fatcatpatterns.com)

# Summer Flowers - Sindy Rodenmayer

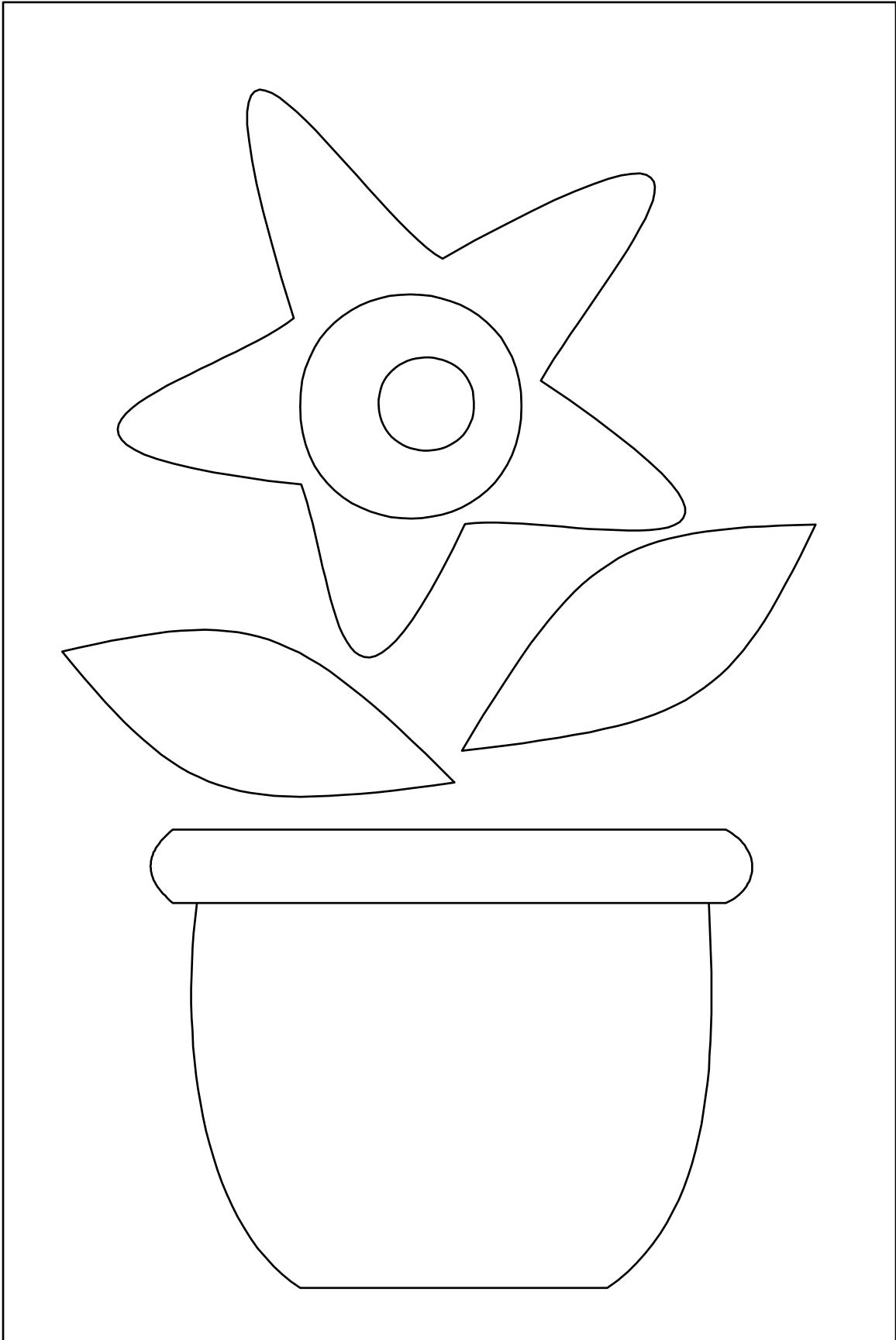

[www.fatcatpatterns.com](http://www.fatcatpatterns.com)

# Summer Flowers - Cindy Rodenmayer

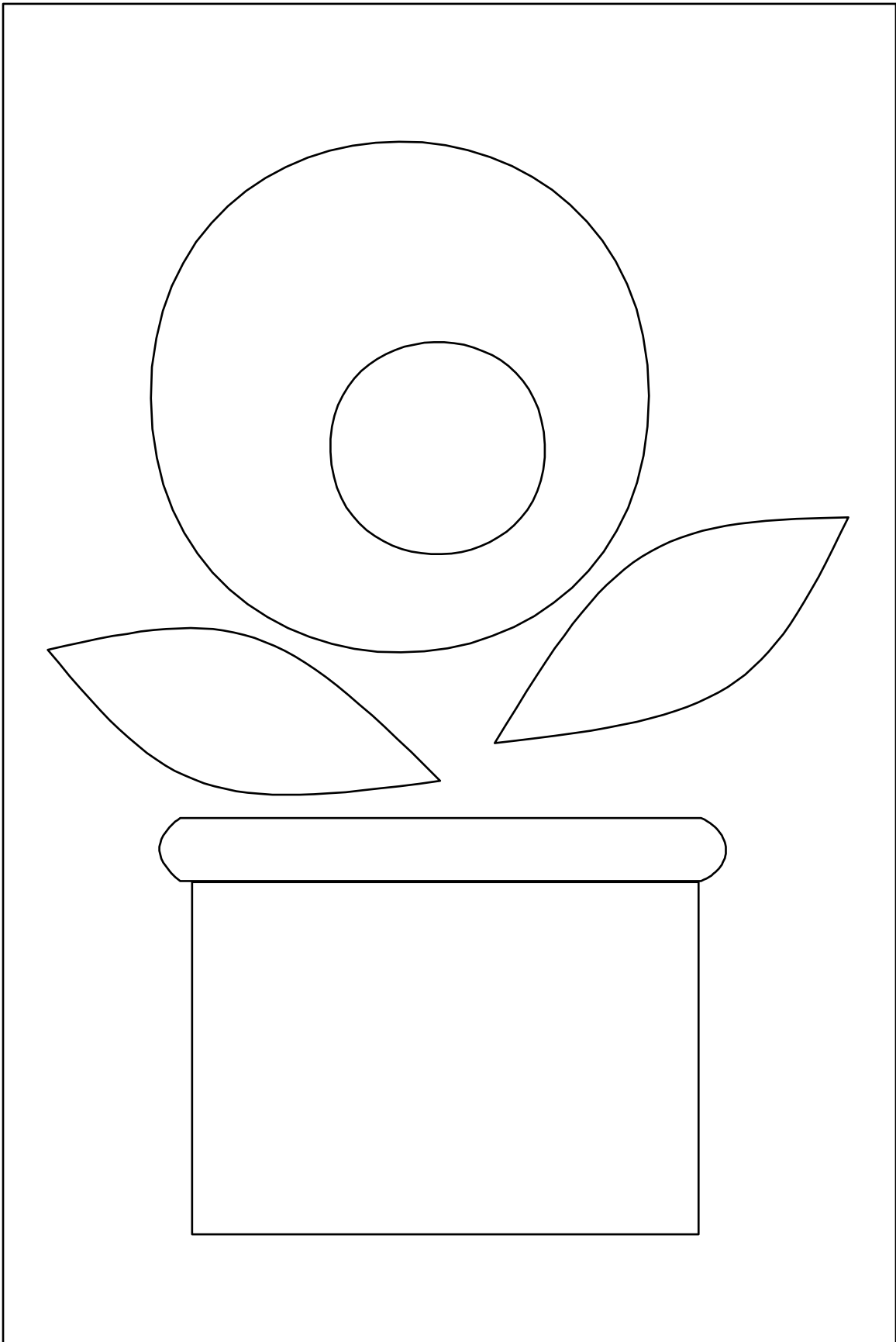

[www.fatcatpatterns.com](http://www.fatcatpatterns.com)